

USER MANUAL

**VALENTINO 1000 F, VALENTINO 1000 LF/FR,
VALENTINO 1000 LFR**

G20/G25 (Natural Gas) G30/G31 (Propane-Butane/Propane)



**Produced by:
Planika Sp. z o.o.
Bydgoska 38
86-061 Brzoza
Poland**

IT IS OBLIGATORY TO READ AND STORE THIS INSTALLATION

MANUAL.

TABLE OF CONTENTS

1. INTRODUCTION	4
2. GENERAL INFORMATION	5
3. SAFETY	5
3.1. Safety instructions	7
3.2. Safety instructions for the use of gas cylinder	8
4. USAGE	9
4.1. First use	9
4.2. Discoloration of walls and ceilings	9
5. REMOTE CONTROL	10
5.1. Display and buttons	10
5.2. Explanation of symbols	11
5.3. Setting connection between the remote control and the receiver	11
5.3.1. Battery exchange	12
6. USER MENU	13
6.1. Eco Flow	13
6.2. Relay - control of additional optional lighting	14
6.3. Fan or damper control	14
6.4. The choice of control options	15
6.5. Date and time settings	16
6.6. Setting the time schedule	16
7. INSTALLATION MENU	17
7.1. Time format of 12-hour or 24-hour	17
7.2. Time schedule (1day, 5 + 2, 7 days or manual)	18
7.3. The periods during the day (II, IV or VI)	18
7.4. User Menu Settings	19
8. CONTROL	19
8.1. Manual control	19
8.1.1. Ignition of the device	20
8.1.2. Flame height adjustment	21
8.1.3. Temperature regulation	21
8.1.4. Temporary disruption of the temperature control	22

8.1.5.	Switching on and off the side sections of the furnace.....	22
8.1.6.	Turning off the device	22
8.2.	Automatic control - Time Schedule	23
8.2.1.	Temporary change of temperature setpoint	23
8.2.2.	Temporary disruption of the time schedule	23
9.	SIGNAL QUALITY.....	24
10.	TROUBLESHOOTING	24
11.	MAINTENANCE.....	27
11.1.	Cleaning of the glass with anti-reflective coating.....	27
11.2.	Assembly of the glass	28
11.3.	Dissassembly of the glass.....	31
12.	ENVIRONMENTAL PROTECTION.....	34
12.1.	The device	34
13.	WARRANTY.....	34
14.	TECHNICAL SPECIFICATIONS	35
15.	CONTACT DETAILS OF THE MANUFACTURER	35

1. INTRODUCTION

The Planika company designs and manufactures gas heating devices that meet the highest standards of quality, efficiency and safety. The device has a CE marking, which means that it meets the essential requirements of the Directive of the European Parliament and European Council 2009/142 / EC of 30 November 2009 and Regulation (EU) 2016/426 relating to Devices burning gas and compliant is with Standard EN 613 on convection space gas heaters, and EN 778: 2010.

Each gas fireplace produced by Planika is subjected to factory quality control, during which it undergoes rigorous safety tests. Materials of the highest quality used for its production guarantee the user a smooth and reliable functioning of the device.

The device is delivered together with the instruction manual and assembly instructions. The assembly instructions provide the necessary information to install the device in such a way that it works properly and safely. In addition, you can find technical data about the device, information on its maintenance and possible failures that may occur, along with their possible causes and how to resolve them.

WARNING! The installer must be a certified and qualified specialist in gas heating and electricity and should have all the qualifications required by local law.

CE Declaration of conformity

We hereby declare that both the design and construction of a gas heating device manufactured by Planika Sp. z o.o. (with registered office at Bydgoska 38 86-061 Brzoza Polska) meet the essential requirements contained in the Directive and the Ordinance on gas appliances.

Product: Convection space gas heater with closed combustion chamber, equipped with concentric air combustion pipe system with natural gravity, type C11 (without a fan) and the type of C31 (without a fan) and C91 (without a fan).

Type: MONROE 900, MONROE 1150, VALENTINO 1000, VALENTINO 1300 in versions: LF, F, FR, LFR

Directives: 2009/142 / EC; 2014/35 / EU; 2014/30 / EU

Regulation: 2016/426 / EU

Standards: EN-613; EN-613/A1; PN-EN 778:2010; PN-EN 437+A1:2012; PN-EN 60335-2-102

The notified body: the Oil and Gas Institute - National Research Institute (Lubicz 25 A street, 31-503 Kraków, Unit number: 1450) carried out and on 27/04/2017 issued the certificate no. GAR1450CS0005 for the above mentioned devices.

The company's quality control system guarantees that the mass-produced devices meet the essential requirements of the applicable Directives and Regulations as well as the standards contained therein. This Declaration is annulled if any modifications are made to the device without the prior written consent of Planika.

Brzoza 02.02.2018

PREZES ZARZĄDU
Jarosław Dąbrowski

Chairman of the Board

Jarosław Dąbrowski

The object of the declaration described above is in line with the relevant EU legislation: Directive 2009/142 / EC (until 20 April 2018) and Regulation (EU) 2016/426 (from April 21, 2018)

2. GENERAL INFORMATION

VALENTINO gas fireplaces are gas powered heating devices with closed combustion chamber, which use first-class advanced automation to control the gas valve. The device complies with European directives with regards to safety, the environment and energy consumption. Thanks to the use of the concentric flue system, the air supplied to the combustion chamber via the outer pipe is drawn from outside the building. The entire system is completely closed, which prevents the exhaust gases entering directly into the room where the fireplace is located. This provides the user with 100% security thanks to separation of the products of combustion, which are removed efficiently out of the building through the inner pipe of concentric system.

VALENTINO Gas fireplaces series are intended for indoor use only, and can be powered by natural gas or liquefied natural gas propane or propane-butane. The device is manufactured in four variants of glazing, in accordance with the accessibility for each installed, so as to be able to fully meet the needs of even the most demanding customers. Regardless of the glazing and the length of the chimney, VALENTINO fireplaces are equipped with automatic control and protection of the same type, and their connection to the gas system and the flue system is identical. The user also has the option of choosing the version of the interior of the fireplace and control it by using remote control supplied together with the device, through automation system of intelligent buildings or use for this purpose a built-in thermostat unit.

3. SAFETY

WARNING! It is obligatory to carefully read the installation and operating instructions before installing and using the fireplace series VALENTINO. This manual should be retained for the life of the device.

WARNING! The device must be installed in accordance with the relevant national and local regulations. Connection to the flue pipe, wall and roof transitions as well as all elements used to install the fireplace should be made in accordance with applicable standards of national construction law.

To ensure the safe installation and trouble-free operation, please use the following precautions and observe the following safety rules:

- The device can be installed and serviced only by certified and skilled professional specializing in the field of gas heating and electricity.
- The installation of the unit must allow trouble-free access to all components which may require maintenance and service and free access to the front window closing system.
- Do not use the device before you fully install it in the chosen destination.
- Fireplace series VALENTINO should be monitored at least once a year in accordance with this installation manual and as well as all applicable national and local regulations concerning safe installation and use of gas appliances.
- Make sure that the information on the nameplate are consistent with the local type of domestic gas and pressure.

- Do not change the structure of the device and its sealed components or modify the default settings of the fireplace.
- The components of the control system with the gas valve cannot be exposed to moisture.
- Carbon dioxide (CO₂) or powder extinguisher must be placed near the unit.
- Before connecting the device you should familiarize yourself with all connecting schemes (including electric), set out in the manual.
- The first time you turn on the fireplace VALENTINO, it is necessary to use it at the maximum level of the flame for a few hours so that the elements warm themselves, and possible small residues of paints, coatings and lubricants will evaporate.
- During the first hours of use of the device, additional ventilation and ventilation of the room is recommended, to quickly remove the characteristic smell fire resistant paint.
- **WARNING!** When you first start your device, the installer should perform the leak test on all gas connections, check the connections of all elements of the system (including the proper connection to the concentric air combustion system) and check the correct operation of all the items, in particular system of ignition and flame failure protection system.
- Do not move the device during its operation.
- The surface of the fireplace series VALENTINO may strongly heat up during use - up to more than 100 °C.
- **WARNING!** Accessible parts of the devices, including the glass, can become very hot. You absolutely must protect children from contact with the working device!
- Do not operate the machine without inserting the front glass.
- In case of failure of any of the glass panels, please contact your service provider or distributor.
- The device should be installed away from flammable materials.
- All metal parts of the fireplace series VALENTINO are constructed of materials resistant to rust or covered with corrosion coating.
- Never leave the fireplace VALENTINO unattended (as in the case of any other type of fireplace or fire in the room). Fireplace series VALENTINO should be installed out of reach of children, unauthorized persons and animals so direct contact with hot parts of the fireplace is not possible.
- In case of feeling any gas leaks, immediately turn off the fireplace and, depending on the type of fuel, close the main valve on the gas cylinders LPG or close the valve supplying natural gas to the device. You should also ventilate the room in which the fireplace is installed and contact the service staff.
- If the unit is not used for a long time, depending on the type of fuel, close the main valve on the LPG cylinder or close the valve supplying natural gas to the device.

3.1. Safety instructions

- **WARNING!** The device is powered by a voltage of 230 V AC, 50 Hz
 - VALENTINO fireplaces are not standalone devices and are intended only for installation.
 - Co najmniej raz w roku należy zlecać przegląd konserwacyjny urządzenia. At least once a year you should make an overview of the device maintenance.
 - Always observe the minimum distances between combustible walls of the housing and the device.
 - Combustible materials should be placed no closer than within 1 m from the unit.
 - Only decorative accessories attached to the device by the manufacturer should be placed on the furnace (logs, stones, vermiculite or ash imitation). These accessories should be installed as described in this manual. Incorrect placement of decorative materials may result in shortening the useful life of the furnace and its damage.
 - **WARNING!** Make sure you don't place any decorative elements around the ignition and ionization electrodes.
 - Before the final installation and before starting to construct the fireplace housing, make sure that blast-resistant flaps at the top of the device are in correct position and whether they were properly attached to the sealing surface.
 - If the ignition of the device is incorrect or the Fireplace will fail, you should close the gas valve and contact the installer and make sure that the device is not energized.
 - If there is no ignition of the device after three restarts and permanent lock of the device activates, reset by disconnecting from the power source may be impossible. In such cases, please contact your distributor or installer.
 - In the event of damage or break the glass, the device cannot be used and you must close the gas valve and immediately replace the glass
 - The remote control should be kept out of reach of children and unauthorized persons not familiar with the unit's User Manual.
 - If the device is not used for an extended period of time, close the gas valve and remove the batteries from the remote control. This will prevent damage due to battery leakage.
 - It may happen that the device will turn off automatically and immediately turns on. This is not a failure, but test procedure resulting from the design and configuration of the driver, because the control device is subject to strict safety requirements. From the moment you connect a device driver to a power source, the driver will perform this test every 24 hours. If the device is currently lit, it goes off and immediately turns on again.
- WARNING!** Operate the device using the remote control with use of the built-in thermostat or (optional) tablet with a special application or home automation system, the device can turn on when you are not at home. Therefore, in such cases, you should take extra precautions before switching on the machine without supervision (eg. an additional switch of electricity on the power cord; closing the ball valve on the gas supply line to the device) in order to avoid damage to objects or injuries and the use of to all safety instructions in this manual.

3.2. Safety instructions for the use of gas cylinder

- Use only the type of gas and pressure specified on the label by the manufacturer.
- Gas cylinders should always be in an upright position - both during use and transport.
- A storage of the gas cylinder should be located in a place easily accessible to allow its immediate closure.
- During installation, never approach the gas flame or any other source of fire.
- Gas cylinder should not be closer than 1.5 m from the fireplace VALENTINO.
- Any leaks should be located using a mixture of water and foaming cleaning fluid. The resulting air bubbles indicate a leak.
- Always use a pressure reducer between the cylinder and the device. Replace pressure regulator at least every 5 years. Permissible pressure: 30mbar, 37mbar (recommended), 50 mbar. Use only regulators that meet the requirements of European Standard EN16129.
- Use only approved and certified cables connecting gas (flexible hose). Replace them at least every 2 years.
- Flexible hose supplying gas to the unit should be located away from sharp edges and hot surfaces. Avoid bends and twists of flexible connections along the whole length.
- Note that the gas cylinder LPG should be installed in well-ventilated areas. LPG gas is heavier than air and its accumulation on the substrate can lead to the formation of explosive mixtures.
- Optional housing, which cylinder of LPG will be placed at, must have adequate ventilation. It must have an upper ventilation opening above the top of the cylinder (with min 1/100 base surface of the installation) and a lower vent opening at its base (with min 1/50 base surface of the installation).
- Turn off gas cylinder, if the device is not in use.
- Filling the gas cylinders should only be done at certified gas filling stations.
- Exchange of empty bottles for full should take place only at authorized points.

4. USAGE

Before first use of the fireplace, make sure that all connections of individual elements of the system have been made according to the instructions. Incorrect connection of system components for gas or faulty connection concentric air combustion system may cause an improper operation of the device or damage it.

4.1. First use

The first time you turn on the fireplace VALENTINO, it is necessary to use it at the maximum level of the flame for few hours so that the elements warm themselves, and possible small residues of paints, coatings and lubricants will evaporate. During this period, additional ventilation and ventilation of the room where the appliance is installed is recommended, because the characteristic smell of evaporating powder paint may be felt for about another hour of use. It can be particularly sensitive to volatile vapors may be pets (mainly birds).

If during your first startup of the device, sediment will appear on the inner surface of the glass (glasses), turn off the device and allow it to cool to room temperature, and then clean the glass (see section 11. 1). The formation of the RAID is caused by burning volatile components of paints, which initially may also have an impact on the image of the flame.

Fireplace installed in the housing should be fired for the first time after complete drying of all the walls of housing. This prevents the formation of cracks due to shrinkage of the materials. If the walls of the fireplace housing are made of stone materials, leave it to dry for at least 6 weeks prior putting the unit into operation.

4.2. Discoloration of walls and ceilings

When using gas heating, you can meet with a phenomenon of electrolytic colouring of walls and ceilings. It is caused by the movement of air convection, and dust particles contained therein. Brown discoloration may also occur during combustion of substances as a result of inadequate ventilation, smoking, the use of candles and oil lamps. These problems can be partially prevented by ensuring adequate ventilation the room in which the device is located.

5. REMOTE CONTROL

Urządzenie wyposażone jest w bezprzewodowy, radiowy pilota zdalnego sterowania (868MHz). Umożliwia on zarówno ręczne sterowanie urządzeniem, jak również sterowanie na podstawie harmonogramu czasowego lub zadanej temperatury w pomieszczeniu poprzez wbudowany w pilocie termostat. Temperaturę i wysokość płomienia można regulować w trybie manualnym. W trybie harmonogramu czasowego urządzenie sterowane jest wyłącznie w oparciu o zadaną przez Użytkownika temperaturę, w porównaniu z temperaturą w pomieszczeniu, w którym zainstalowane jest urządzenie (na podstawie odczytów z termometru znajdującego się w pilocie zdalnego sterowania).





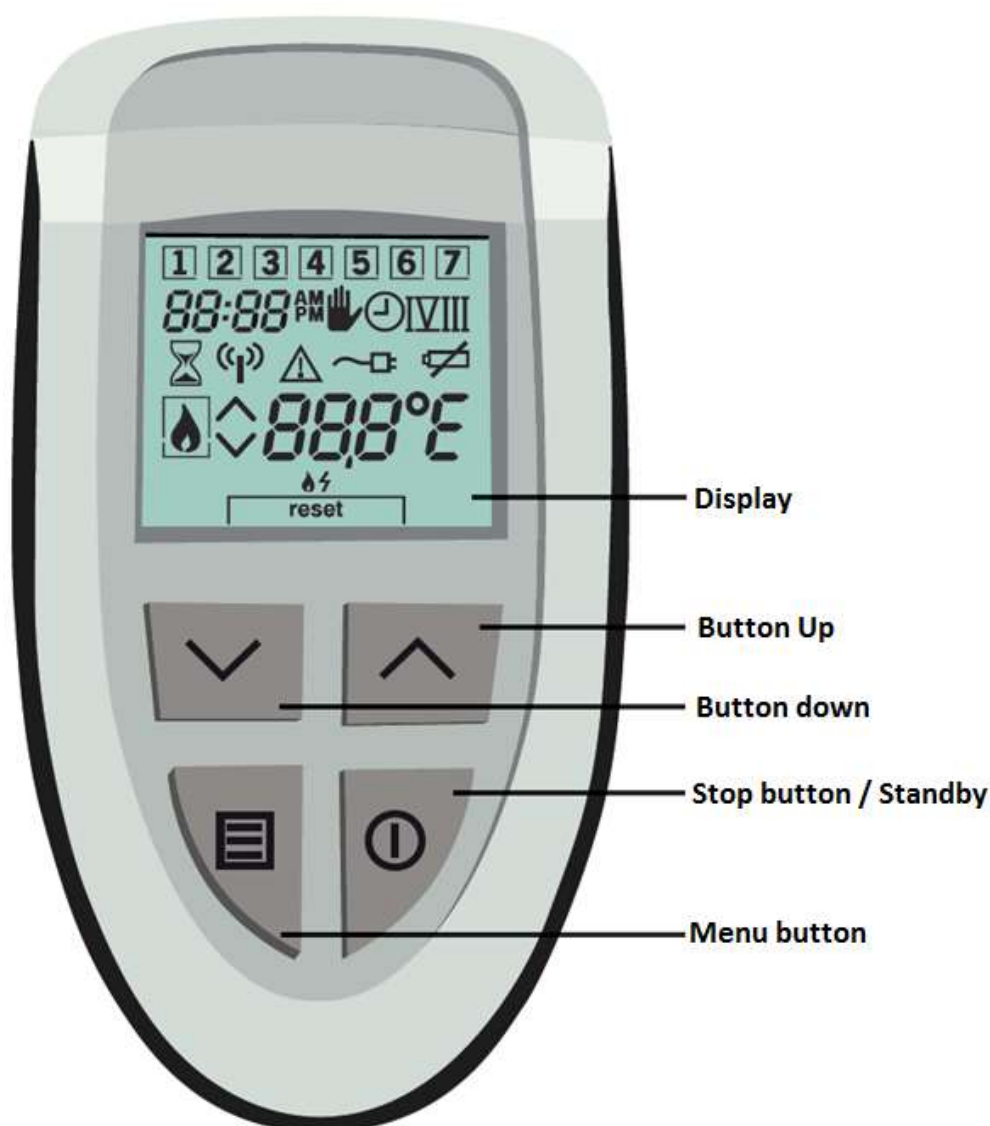





The device is equipped with Wi-Fi, radio remote control (868 MHz). It allows both manual device control, as well as control based on schedule or set temperature in a room by the built-in remote control thermostat. The temperature and the flame height can be adjusted in manual mode. In Schedule the unit is controlled solely on the basis of specified by the user, in comparison with the temperature in the room where the device is installed (based on readings from the thermometer located in the remote control).

5.1. Display and buttons







Picture 1: Rmote Control

5.2. Explanation of symbols

	Manual Control
	Active timetable
I II III IV V VI	Active period
	Closed fireplace (on the left) and open (on the right)
	Decorative flame on
	Decorative flame can be ignited.
	Decorative flame error, you can reset
∨ ^	Burner off/setting down (on the left) Burner on/setting up (on the right)
	Operation in progress (e.g. when decorative flame is turning on)
	Failure
	Radio communication
	Batteries low (flashing symbol)
88:88 ^{PM}	Display format of discharge 12-hour or 24-hour
1 2 3 4 5 6 7	Days of the week. Square indicates current day
888°C	Temperature display
Err	Temperature sensors error

Buttons:

	Increase settings or change the selection
	Decrease settings or change the selection
	Choose the menu and choice of the menu
	Stop the set up menu or go to standby mode



5.3. Setting connection between the remote control and the receiver

After replacing the batteries or during your first installation, you must establish the communication code between the remote control and the receiver to be able to use the wireless remote control. The receiver is in the mounting bracket together with the gas valve and electronic control unit.

The remote control can communicate with a device only when it is registered on the device. To do this, you must do the following:

- Press and hold the button  on the remote control for 10 seconds.
- Then press for a short time the same button several times until screen „1” appears.



- Briefly press buttons  and  at the same time until screen 2 appears. After a successful completion of the process of setting up the communication, startup screen will be displayed.
If the connection fails, screen 1 will appear again.

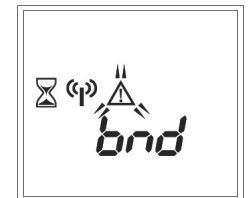

Setting a new communication code is required after each battery replacement or after power failure for more than 5 minutes.

WARNING! It cannot be ruled out, although it is unlikely that the ignition of the device can be started unintentionally by other remote controls (for example, remote control of another gas heater, car remote control or remote control for garage doors working in the 868 MHz band). As a result, the device can be ignited at the wrong time, also during our absence. In the event of such situation, you must take the following preventive measures:

- establish a new communication code between the remote control and the receiver (if accidental ignition took place).
- Close the gas valve near the device, if the device will not be used for an extended period of time. This is the safest remedy.
- Change the position of the receiver to minimize the possibility of receiving unwanted radio signals.
- Follow the specific instructions of the security measures, even if the device is not in use.

5.3.1. Battery exchange

Before using the remote control you must place the two supplied batteries (type AA). After inserting the batteries and after connection to receiver, the remote control is ready to operate the fireplace by manual adjustment of the flame height. To extend battery life, after some time the button was last pressed, the screen goes blank, unless the device is turned on.

If the display shows the flashing symbol , replace the batteries. If the batteries are completely discharged, the display goes off. Therefore, you should replace the batteries in the remote control. To change it, you should:

- Remove the back cover of the remote control by moving it a few millimeters down (Picture 2, Part 1) and lifting it to the top.
- Remove the old batteries from the housing.
- Place the new battery pack in the housing (Picture 2, Part 2).
- Mount the back cover of the remote control, placing the tabs A and B of the rear cover (Picture 2, Part 3) in the corresponding notches of the remote control housing (Picture 2, Part 2).

- Push the rear cover upwards to lock it.
- After replacing the batteries, re-establish communication code, the current time and day of the week (it is necessary if you use the time schedule).

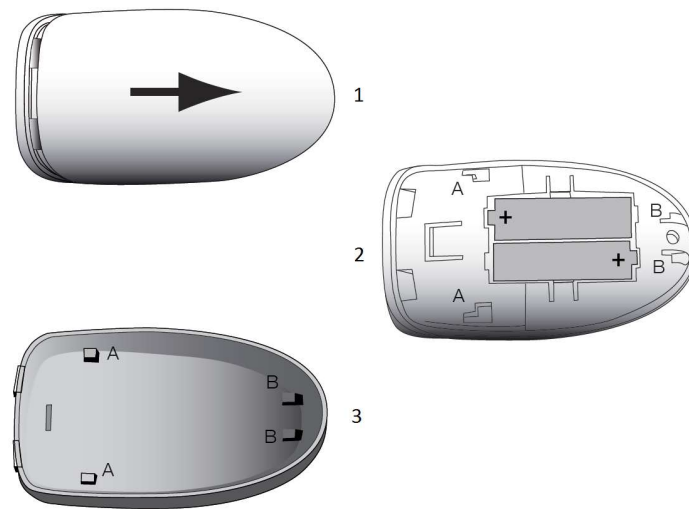

Picture 2: Battery exchange in the remote control



WARNING! Do not throw exhausted batteries together with other household waste, but dispose of them as chemical waste.

6. USER MENU

The user menu is composed by default with five screens that allow you to access the following features:

- Screen 1: Eco Flow
- Screen 2: Relay (additional electric receiver such as lighting)
- Screen 3: Fan / Damper
- Screen 4: Choice of control options
- Screen 5: Time menu



If the user do not plan to use all the options and related features available in the user Menu, the user can disable it through the appropriate configuration in the installation Menu. These features will no longer be visible in the user Menu on the remote control.

To activate the user Menu, you should press and hold button  for 2 seconds. You can go out of User Menu by pressing  button or after waiting five seconds of pressing the last button.

6.1. Eco Flow

Eco Flow, allows you to change the height of the flame automatically, within a programmed range, without user interaction, and without need to manually change the height of the flame. This enables you to save energy and reduce gas consumption with satisfaction of preserving the beautiful appearance of the flame Using the remote control, this feature can be enabled and disabled. Please note, however, that this is only possible when the device is turned on. By default, the Eco Flow is turned off.

To activate or deactivate the feature Eco Flow, you should:

- Go to the Screen 1 of the user menu, by pressing and holding the button  for 2 seconds.
- Activate or deactivate the Eco Flow by pressing the arrow keys on the remote control  or  („1” means activating and „0” means deactivating of Eco Flow).







Screen 1.

6.2. Relay - control of additional optional lighting

Gas valve control electronics gives you the ability to connect an optional lighting (for example, to highlight the Interior of the housing) or any other electric receiver and allows you to control it with the remote control. Built-in relay can be used to control the AC Receiver (max 230V AC/0, 5A).

This feature can only be turned on and off by using the remote control. To activate or deactivate receiver connected to electric relay, you must:

- Go to Screen 2. Of the user menu, by pressing and holding button  for 2 seconds. Then, again press the button .
- Enable or disable electric receiver function by pressing the arrow buttons on the remote control  or  („1” means activating and „0” means deactivating).







Screen 2.

6.3. Fan or damper control

Electronics controlling gas valve gives you the ability to connect and control via optional fan or throttle powered with AC (max 230V AC/0, 8A), mounted for example in the wall of the fireplace housing. The fan can be used to improve air circulation within the housing or to distribute warm air from inside the housing to the other rooms.

Using the remote control this function can only be switched on and off. To enable or disable connected fan you should:

- Go to Screen 3. Of the User Menu, by pressing and holding the button  for 2 seconds. Then briefly press twice the button .
- Enable or disable fan by pressing the arrow buttons on the remote control  or  („1” means activating and „0” deactivating).





Screen 3.







6.4. The choice of control options

The remote control is configured by default to manual control mode. To use the time schedule, select the appropriate option in the installation Menu (Chapter 7). After proper configuration in the installation Menu, features of the time schedule will be available and you will be able to find them on the screen 4 (and subsequent) in the user Menu.

WARNING!!! When using the Application for mobile devices, the Temperature Control mode with Time Schedules is not available. There are also invisible all screens on the Remote Control Menu related to the configuration and setting of time schedules.



To make the choice of how to control a fireplace:

- Go to Screen 4 of the User Menu, by pressing and holding the button  for 2 seconds. Then briefly press three times the button .
- There are three possible control modes of Fireplace control, symbolized by two flashing symbols:

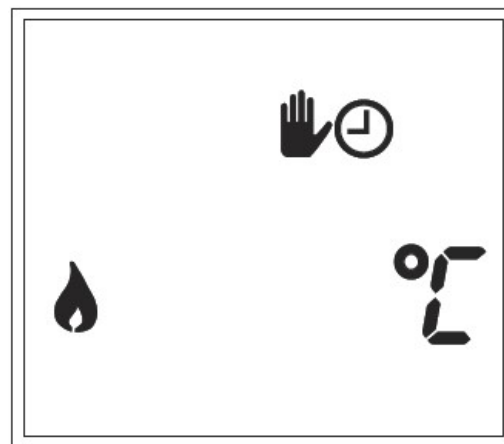
-  +  ○ Manual control with adjustable flame height
-  +  ○ Manual control with the temperature control,
-  +  ○ Time schedule (temperature control).



Screen 4.







- the desired way to control a fireplace you should select by pressing the arrow buttons  or  on the remote control.
- Leave the Menu by pressing a button  or after waiting five seconds of pressing last button.

6.5. Date and time settings

In the Time Menu (Screen 5 User Manual) the following settings are available:

- Time,
- Day of the week,
- Time schedule.

To change the current settings, you should:

- Go to Screen 5 in the User Menu, by pressing and holding the button  for 2 seconds. Then briefly press three times the button . The currently set time starts flashing.
- Using the arrow keys  or  set the correct time on the remote control.
- Press again the button . Days of the week will flash.
- Using the arrow keys  or  set the correct day of the week.

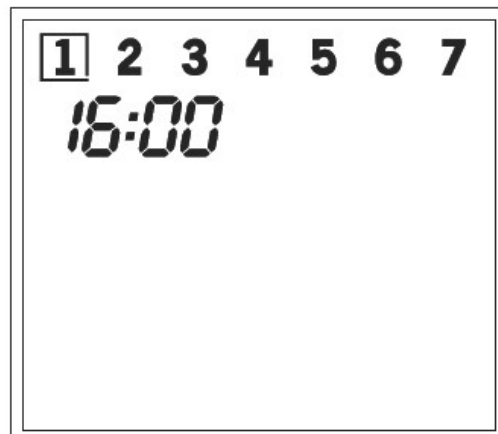

Open square indicates the selected day. **WARNING!** Weekdays are not visible if you choose a one-day time schedule.





6.6. Setting the time schedule

Depending on the choices made in the Installation menu available options may include the following time schedule:





- Time schedule with the same settings for each day
- Time schedule with separate settings for weekdays (Monday to Friday) and the weekend
- Time schedule with separate settings for each day.

For each day, you can set two, four or six different periods. Time schedule can easily set the start time and set temperature point for each period. Setting all time schedules is done in the same way, regardless of the amount selected in the Installation menu.

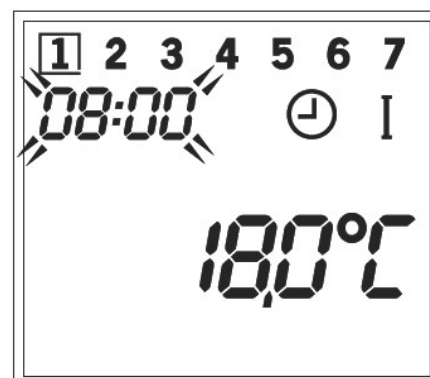
To change settings of the time schedule you should:

- Press and hold the button  for 2 seconds, then again briefly press the button six times . Start time of the first period flashes.
- Using the arrow keys  or  on the remote control set the correct start time of the first period.



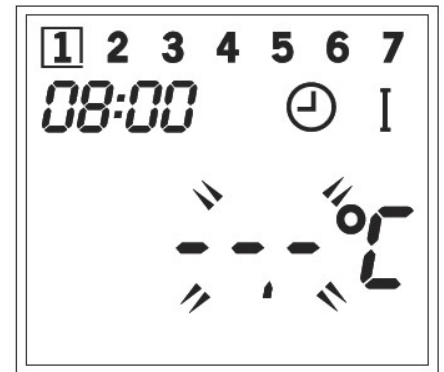
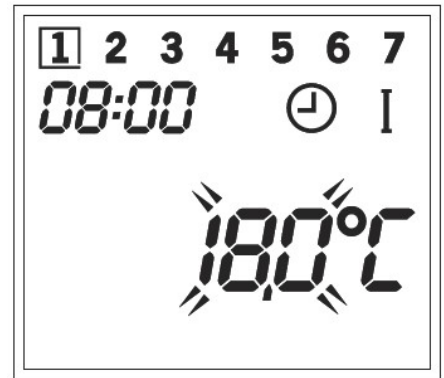

- Press the  button again. Desired temperature of the first period flashes.
- Using the arrow keys  or  set the correct temperature and time on the remote control.
- Press the  button again and repeat the above steps to set the desired start time and the setpoint temperature for all periods and days.
- It is also possible to shut down the device at specific time in the current set period. To do this, select „--,-" when setting the desired temperature.



7. INSTALLATION MENU



The following options are available in the installation menu:

- Time format of 12-hour or 24-hour,
- Time Schedule (1 day, 5 + 2, 7 days),
- The number of periods during each day (II, IV or VI).

To activate the Installation menu you should exit the User Menu (if it is enabled), and then press and hold the button  for 10 seconds. You can leave Installation Menu after pressing the button  or after waiting five seconds of pressing last button.

7.1. Time format of 12-hour or 24-hour



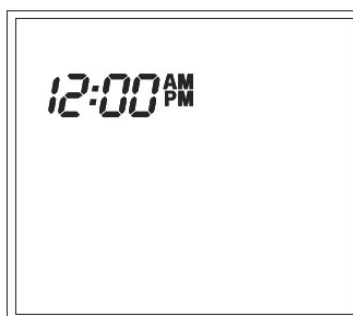
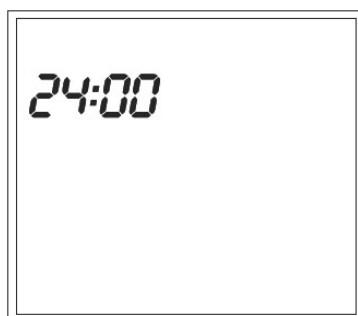

To change the time display format:

- Press and hold the button  for 10 seconds. The currently selected time display format starts flashing.
- Change the format of the time display by pressing the arrow buttons on the remote control  or .



7.2. Time schedule (1day, 5 + 2, 7 days or manual)

To change the time schedule you should:



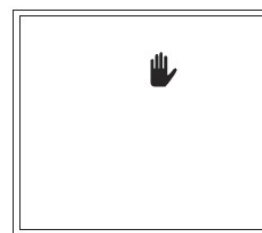
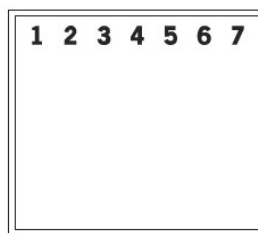
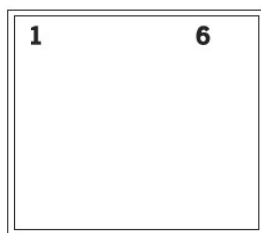
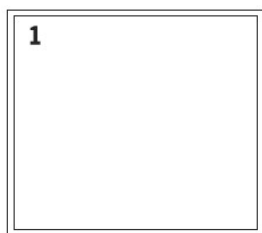

- Press and hold the button  for 10 seconds, and then briefly press again the  button. Screen with one of the four currently used timetable will appear. Screen with the symbol  means the manual mode and the lack of the currently selected time schedule. In this case, it is only possible to manually control the height of flame.
- Select the desired time schedule by pressing the arrow keys on the remote control  or .



- Time schedule with the same settings for each day.
- Time schedule with separate settings for weekdays (Monday to Friday) and the weekend.
- Time schedule with separate settings for each day.
- Manual Mode.

7.3. The periods during the day (II, IV or VI)

To change the number of available periods during the day (II, IV lub VI) you should:

- Press and hold the button  for 10 seconds, and then briefly press again the  button. The currently selected number of periods per day starts flashing.
- Select the desired number of periods per day by pressing the arrow keys on the remote control  or .

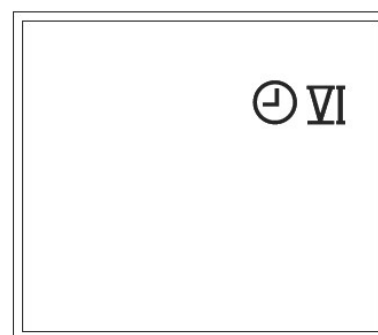
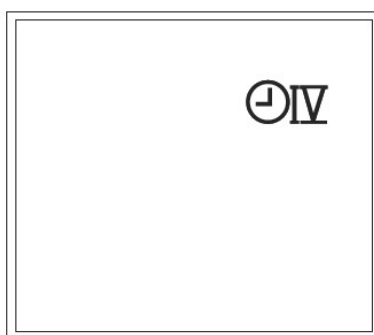
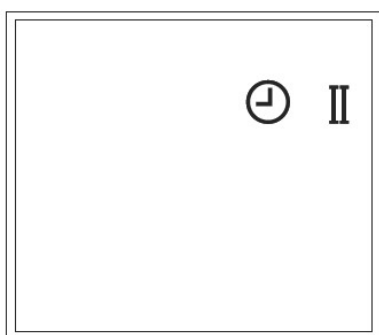



- II – two periods during the day,
- IV – four periods during the day,
- VI – six periods during the day,



7.4. User Menu Settings

It is possible to configure the options in the User Menu, including the deactivation or change the default settings of Eco Flow function, work status of Relay "L" and use of Fan/Damper "B".

To change the default settings for the options that are available in the user Menu you should:

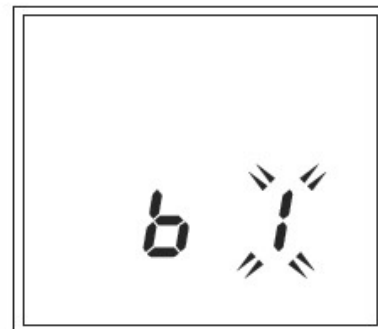
- Press and hold the button  for 10 seconds, and then briefly press again the  button. Current state of function Eco Flow marked with digit will start flashing.





- Select the desired state of the option available in the user Menu by pressing the arrow buttons on the remote control  or :
 - 0 = not available in the menu
 - 1 = by default, always off
 - 2 = by default, always on
 - 3 = last position
- To go to the configuration of the Relay operating mode and the Fan support you must again press the  button.

8. CONTROL

The remote control has a display and four buttons. Thanks to this, operation of the device is simple and settings can be easily changed. There are two settings Menu available:

- User Manual (see chapter 6)
- Installation Manual (see chapter 7)



To activate the User Menu, press and hold the button  for at least 2 seconds. To activate the Installation menu, press and hold the button  pressed for 10 seconds.

8.1. Manual control



After selecting the device manual control in the user Menu, the device switching on and off as well as the temperature control or the height of the flame is carried out manually. Otherwise (if the device is configured in time schedule mode) manual control of the device is not possible, and the process of switching on and off is performed automatically according to the set switch-on time and according to set target temperature in the room.

WARNING! If you select the automatic mode of controlling the fireplace, it is important that the remote control is not in the immediate vicinity of the fireplace and lay freely in easily accessible location. This will allow you to avoid passing incorrect information by the thermometer (integrated in the remote control) to receiver controlling the operation of the fireplace, about the temperature in the room.

8.1.1. Ignition of the device

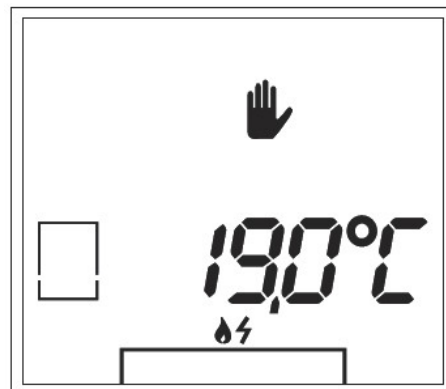

To start the process of firing the device, which is ready for use in manual mode, simultaneously press and hold for at least 2 seconds  and  buttons on the remote control. The gas supply to the furnace will open and you will hear the sound of working ignition electrodes.



During the ignition on the screen of the remote control, symbols  and  will start flashing, which indicates the fact that, the ignition process of the device is taking place and you will also see the hourglass symbol, which will not let you manipulate the fireplace. In the first place the middle section of the device will be lit on 50% of its power. After about one minute solenoid valve gas supply turns on to the side section of the furnace and the device switches to its full performance. The hourglass symbol will disappear which indicates the end of the ignition process.







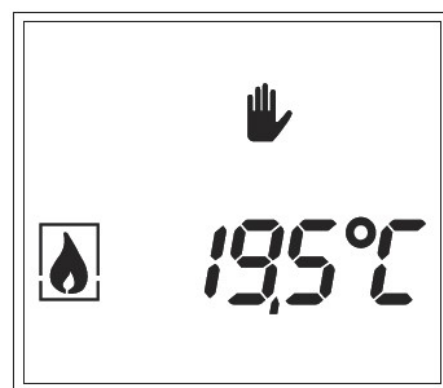

WARNING! If there is no ignition of the device after three restarts and the permanent device lock activates, it may be impossible to reset it by disconnecting the power source. In such cases, contact your dealer or installer.

When the symbol  on the screen will disappear and symbol  will stop flashing, it means that the ignition of the device was completed correctly, and the fireplace is ready to use. From that point on, manual flame height adjustment will be possible.







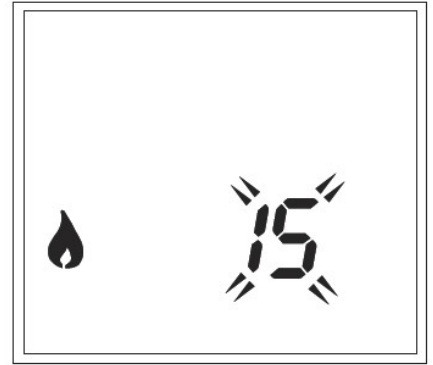

8.1.2. Flame height adjustment

To change the height of the flame, you must press once button  or  on the remote control. You should see on the screen flashing, currently set value of the flame height. Set the required flame height by using the buttons  or . Depending on which button is pressed, the symbol  or  will be briefly visible on the screen. Flame height can be set as a numeric value in the range from 1 (the lowest flame) to 15 (highest flame). By default, the device is started at the highest flame level that can only be adjusted when the machine is turned on. You can go back to the main screen by pressing the button  or wait five seconds after pressing the last key.



8.1.3. Temperature regulation

To control the device through manual adjustment of the desired temperature in the room, proper configuration in the user menu (Section 6.4) will be necessary. The device will then turn on and off automatically depending on the manually set temperature and heat demand. If the room temperature is approaching the temperature set by the user, driver of the device will automatically reduce the height of the flame. If the temperature exceeds the temperature set by the user, the device driver will automatically turn off the fireplace and start it again if the room temperature drops below the temperature set by the user.

To change the desired temperature, press once  or  button on the remote control. The display shows currently set flasing temperature. Set the required temperature by using the buttons  or . Depending on which button is pressed, the symbol  or  will be briefly visible on the screen. Temperature can be set as a value in the range from 5,0 °C to 35,0 °C.





WARNING! The remote control is equipped with a thermostat and must be in the same room as the unit. Place it always in the same place, free from drafts, and do not expose it to direct sunlight and heat radiating from the fireplace.



Back to the main screen can be done by pressing the button  or after waiting five seconds of pressing last button.

8.1.4. Temporary disruption of the temperature control

Although the fireplace in the temperature control mode turns on and off automatically depending on the set temperature, it can also be temporarily disabled by the User.

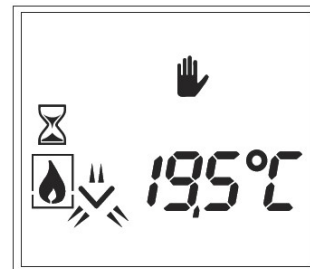
To temporarily turn off the device, press the button . You will see hourglass symbol on the screen and the symbol  will start flashing, which means that device is turning off. Set point temperature cannot be adjusted during a temporary shutting down of the device, operating in temperature control mode.

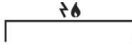



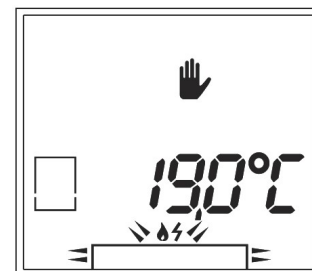

After turning the device off, symbol  will start flashing on the screen, which means that the device can be turned on manually by simultaneously pressing buttons  and . When the device is re-lit, temperature control will be active.





8.1.5. Switching on and off the side sections of the furnace

The side sections of the furnace can be turned on or off by using a combination of buttons on the remote control:

- Simultaneous pressing buttons  and , will disable the side sections of the furnace.
- Simultaneous pressing buttons  and , will enable the side sections of the furnace. The middle section of the furnace enters the highest flame mode (to ensure proper and immediate firing of the side sections) and after a moment, it returns to a level where it was before turning on the side section.

Switching on and off the side sections of the furnace is only possible when the device is in manual mode, which symbolizes the sign  on the screen.

8.1.6. Turning off the device

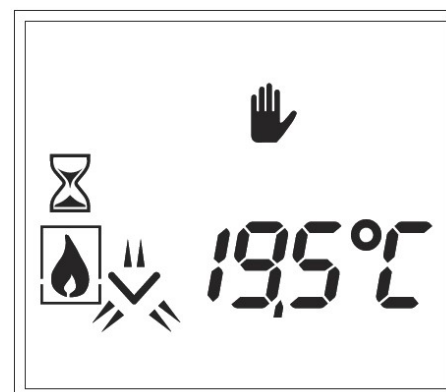

To turn off the device, you should press the  button on the remote control. Hourglass will appear on the screen and the symbol  will start flashing, which means that the turning off the device is in progress. When you turn off the device, the default screen will be displayed again and the hourglass will appear, indicating that for security reasons, rebooting of the device will be possible only after 3 minutes from the moment it was switched off.







8.2. Automatic control - Time Schedule



To control the device using the time schedule, the right configuration in the user menu is needed (Section 6.6). The device will then fully turn on and off automatically depending on the set temperature, the set time of switching on the device in each of the chosen periods and depending on the heat demand.



8.2.1. Temporary change of temperature setpoint

Preset setpoint temperature for a given period within the time schedule can be temporarily increased or decreased by pressing the appropriate buttons  or .

To change the setpoint temperature, press once the button  or  on the remote control. The display shows flashing, currently set temperature.

Temporarily set the desired temperature using the buttons  or .

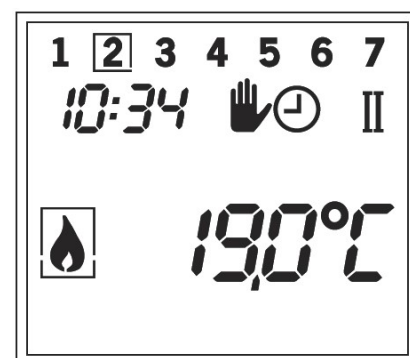
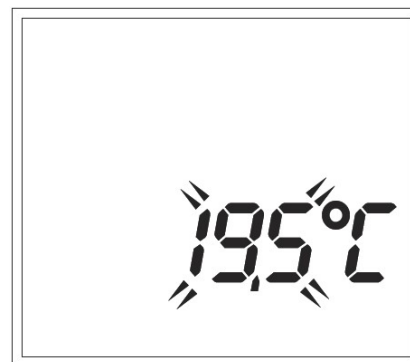

Depending on which button is pressed, the symbol  or  will briefly appear on the screen.

After pressing button  or after waiting five seconds from the time you press the last button, you return to the main screen where in addition the symbol  appears, indicating that the set point temperature was adjusted manually. Temporary temperature change can be canceled, by setting the manually changed value set on the previous value given for the current period. In the case of the transition to a new period, temporary setting is automatically canceled.





8.2.2. Temporary disruption of the time schedule

Although the fireplace in the time schedule mode turns on and off automatically depending on the set temperature, it can also be temporarily disabled by the user.

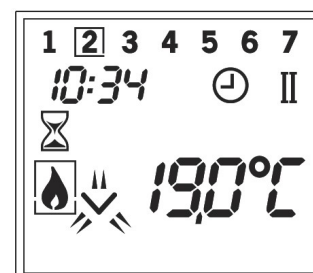

To temporarily turn off the device, press the  button. The display shows the hourglass symbol and the symbol  will start flashing, which indicates that the device is turning off. Set point temperature cannot be adjusted during a temporary disruption of the time schedule.

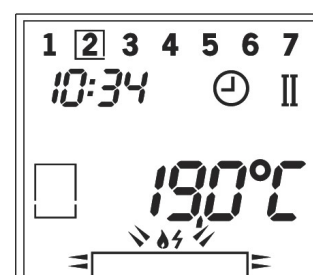

After turning the device off, symbol  will start flashing, which means that the device can be turned on manually by simultaneously pressing buttons  and . When the device is re-lit, time schedule will be active.





9. SIGNAL QUALITY

To check the quality of the signal between the transmitter (remote control) and the receiver located in the mounting bracket together with the gas valve and the control unit, you should press simultaneously buttons  and .

The screen will show the RSSI value (received signal strength indicator), which means:

- from -20 to -80 – good received signal strength,
- from -80 to -100 – Poor received signal strength. In order to improve the signal strength you should place the remote control closer to the unit or change the position of the receiver to minimize the possibility of receiving unwanted radio signals.



In the event of a communication error between the remote and device, this error will be indicated by a failure sign  and the flashing sign of lack of communication  on the remote's screen. Most likely, the distance between the device and the remote control is too large and the remote should be placed closer to receiver. If the error persists despite the change in the distance between the remote and the receiver, you must again carry out the process of establishing communication code (Section 5.1).

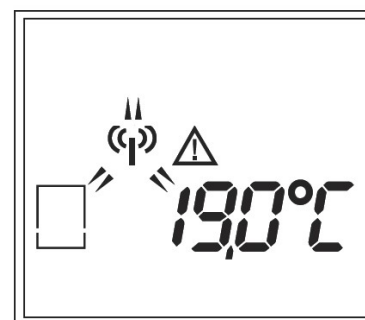



10. TROUBLESHOOTING

WARNING! Installation, repair and maintenance must be performed by trained installer with the appropriate permissions, service company or gas supplier.

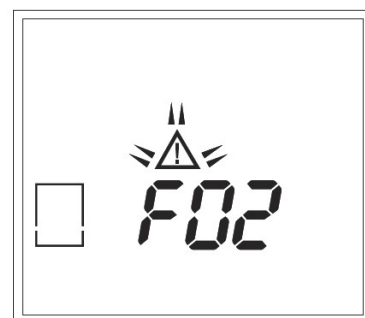
In case of any fault or failure an error code indicating the potential emergency situations will display on the screen of the remote control. The display will show the letter "F", after which you will see a two-digit error code. Full list of error codes is shown in the table below, which presents a summary of any incident that may occur, possible causes and ways to overcome them.



The error code can be reset by simultaneous pressing the buttons  and  on the remote control (when the device is not permanently locked, eg. following repeated ignition attempts). The error code will disappear and it will be possible to restart the device. **WARNING!** You cannot use the device if the fault is repeated. Please contact your installer.

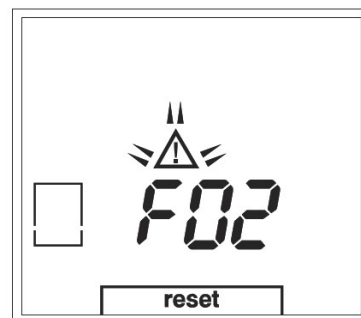

In the case of an error message F01 or F08 you can reset and try to turn the device on up to 3 times in a row. If ignition fails, F00 error appears on the display and ignition is not possible for another 30-minutes.

ERROR CODE	FAULT	POSSIBLE CAUSE	REPAIR
	SMELL OF GAS	IMMEDIATELY CLOSE THE GAS VALVE ON THE GAS CONNECTION. DO NOT USE THE APPLIANCE UNTIL SPILLS ARE FULLY REMOVED	
F00	Flame not detected in time and the burner control doesn't report a failure.	F01, F07 or F08 appeared 3 times	Device blocked. Wait 30 minutes before trying again.
		No spark	Make sure that the distance between the electrodes is 3-4 mm
		No Gas	Make sure, there is a gas connection
F01	The lack of communication between the receiver and the automation controller	Communication cable does not make any contact	Make sure that the contacts of the communication cable ensure correct contact
		Damage to the communication cable	Replace the communication cable
F02	Overheating of the receiver (60 ° c above room temperature)	Poor ventilation by the receiver	Improve ventilation at the receiver
		The receiver is in contact with the hot parts	Move the receiver so that it does not touch the hot parts
F03	Internal NTC sensor(of the receiver) is not working properly	Damaged receiver	Replace Receiver
F04	External NTC sensor is not working properly	External NTC sensor or wiring are damaged	Replace the NTC sensor or wiring
F05	Internal security error	Damaged receiver	Replace Receiver
F06	Lack of communication between the transmitter and receiver	The transmitter is out of range of the receiver	Make sure that the transmitter is located near the receiver
		Any obstacles between the transmitter and the receiver may interfere with the signal	Remove any obstacles between the transmitter and receiver
		Power transmission is too weak	Check the power transmission (see. Instruction Manual Chapter 9)
F07	Flame not detected in time and the burner control doesn't report a failure.	No spark	Make sure that the distance between the electrodes is 3-4 mm
		No Gas	Make sure, there is a gas connection
F08	No ionisation / The burner control reports a failure and the flame could not be detected in time.	No spark	Make sure that the distance between the electrodes is 3-4 mm
			Replace the ignition electrodes

			Check if the cables for the ignition electrode are connected correctly
		No Gas	Make sure, there is a gas connection
		Poor transfer of the flame from the main burner	Check the position of the blocks of wood / debris
			If necessary, remove dust and dirt from the holes of the burner
		Extinguishing of the flame at the ionization electrode (braising or picking of the flame)	Check the tightness of the fireplace combustion chamber, proper adhesion of glass to each other on the edges, as well as correct position of the seals and downforce strip
			Check restrictor setting
		No good flame under ionization pin (suffocating flame)	Check position blocks/chips
		Ionisation electrode not inserted correctly	Place the electrode in the right place
		Blocked ionization electrode (measure ionization current flow, when > 0 and $< 1.8 \mu A$)	Remove any residue vermiculite or debris from the burner
		Faulty ionisation electrode (measure ionisation current if 0 electrode is damaged)	Replace the ionisation electrode
		Triggered shock sensor (shake)	Check the sensor connection. Check whether the construction of the fire housing has not been damaged (cracked)
F12	There has been no release of ESYS	ESYS under permanent blockade	Wait half an hour until ESYS resets itself
F13/F14	(ionisation $< 0.8 \mu A$) Flame loss when only the main burner (F13) is on or both burners (F14) are on	Too low gas pressure or no gas in the system	Check the gas supply
		Damage to the coil of the gas valve	Replace the coil of the gas valve
		Throttling flame	Check the patency of the combustion air system
		24 hour control	Reset using the remote control
		Ionisation pin short-circuited	Remove chips, vermiculite or glow material lying against the ionisation pin
		Ionisation current too critical ($0.8 \leq \text{Ionisation} < 1.8 \mu A$)	Increase ionisation current to $\geq 1.8 \mu A$ by rearranging vermiculite, and removing chips and dust from the burner openings
F15	No automatic control ESYS	Loosening of the automation control	Fix the automatic control
		Not properly installed automatic control	Install properly automatic control
	High Limit error	Electrodes by the gas adjustment block connector are bent	Straighten them
		Damage to the bridge of the upper limit	Check the bridge of the upper limit ESYS
F16	Hardware failure ESYS	Damage ESYS (burner module)	Exchange ESYS (burner module)

11. MAINTENANCE

WARNING! The device should be maintained and serviced by a competent installer.

At least once a year the unit should be checked in order to operate properly and safely. The device cannot be used in case of damage or glass breakage. In this case, close the gas valve and immediately have the glass replaced. Do not change the design and sealed components or modify factory settings of the device under no circumstances.

The user can clean the exterior of the device, without using for this purpose corrosive and aggressive detergents. The warranty does not cover damage to the paint resulting from mechanical damage eg. falling objects or placing them at the border of the device.

11.1. Cleaning of the glass with anti-reflective coating

WARNING! The glass must be removed and cleaned only when it is cooled down to room temperature, and the device is turned off.

To prevent damage to the coating layer on the anti-reflective glass is prohibited to use hard sponges, steel wool, abrasive cleaners and cleaning products containing ammonia.

Most of the sediments formed on the glass can be removed with a microfiber cloth. Other materials, such as paper or kitchen towels, etc., may cause scratches and in the case of anti-reflective glass can also cause permanent damage to the coating. Use only chemically inert cleaners (neither acidic nor alkaline), for example. Instanet or Glassex.

Glass must first be wiped from both sides carefully with a damp cloth (or a soft sponge) to collect all the dirt and then wipe it with a dry Microfiber cloth that came with your device. Always thoroughly dry the glass as formed on the surface stains can irreversibly melt into the glass. In the case of larger dirt, for pre cleaning of the glass, you can use liquid for cleaning ceramic hobs or window glasses. But always at the end of the glass cleaning process, make sure you wipe it dry (after washing off the cleaning liquid with clean water) with a microfiber cloth attached to the device. If the glass is transferred by means of vacuum suction, keep in mind that the rubber suction cup must be clean and dry to avoid damaging the anti-reflective coating. If visible traces of the suction cup will remain on the glass, they should be removed.

WARNING! You should avoid leaving fingerprints on the glass. They will be burned out on it after the device starts working and you will not be able to remove them

11.2. Assembly of the glass

The device is equipped with heat-resistant ceramic glass to withstand temperatures up to 800 ° C. Depending on the glazing of the unit, disassembly and assembly of the front glass takes place in a different way.

WARNING! Avoid leaving fingerprints, because they will burn out on the glass.

To mount the front glass of the device with the front glazing you must:

- Make sure the glass is clean, free from persistent dirt and fingerprints.
- Carefully mount the suction cup in the middle of the glass.
- Holding the glass at angle, insert its upper edge between the body of the fireplace and the horizontal fixing strip (1).
- Slide the glass upwards so that its lower edge is above the lower decorative frame "D" (2).
- Push lower edge of the glass in the direction of the body of the fireplace so that the surface of the glass is in vertical position (3).
- Move the glass down and carefully set its bottom edge inside the horizontal handle.
- Even out horizontally position of the front glass relative to the side walls so that the side edges of the front glass comport with the vertical edges of the side walls.
- Move the horizontal strip fixing front glass "C" (4) to the right until it stops and tighten it with screws "B" (5).
- Make sure that the screws are not tightened too much, because it can then lead to their breakage or damage of the thread.
- Mount the side pressure strips "A" in the holes in the side frame and by pushing them down, lock in the vertical position (6).
- Remove the suction cup.

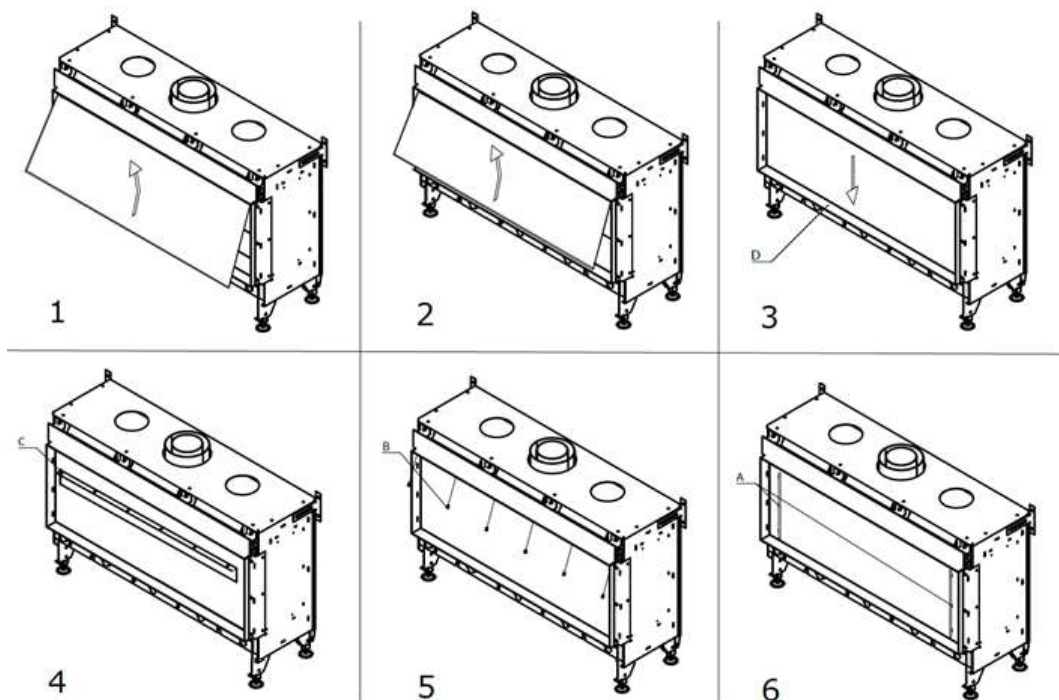

Picture 3: Mounting of the front glass in the fireplace with front glazing

To mount the front glass in the devices with two glasses, you must:

- Make sure the glass pane is clean, free from persistent dirt and fingerprints.
- Carefully mount the suction cup in the middle of the glass.
- Holding the glass at angle, insert its upper edge between the body of the fireplace and the horizontal fixing strip (1).
- Slide the glass upwards so that its lower edge is above the decorative frame "B" (2).
- Push lower edge of the glass in the direction of the body of the fireplace so that the surface of the glass is in vertical position.
- Holding the glass at all times above the decorative frame „B”, move the glass carefully to the left until it stops (or to the right depending on the glazing version) (3).
- Move the glass down and carefully set its bottom edge inside the horizontal handle (4).
- Even out horizontally position of the front glass relative to the side walls so that the side edges of the front glass comport with the vertical edges of the side walls.
- Move the horizontal strip fixing the front glass to the right until it stops and tighten it with screws "A" (5).
- Make sure that the screws are not tightened too much, because it can then lead to their breakage or damage of the thread.
- Remove the suction cup.

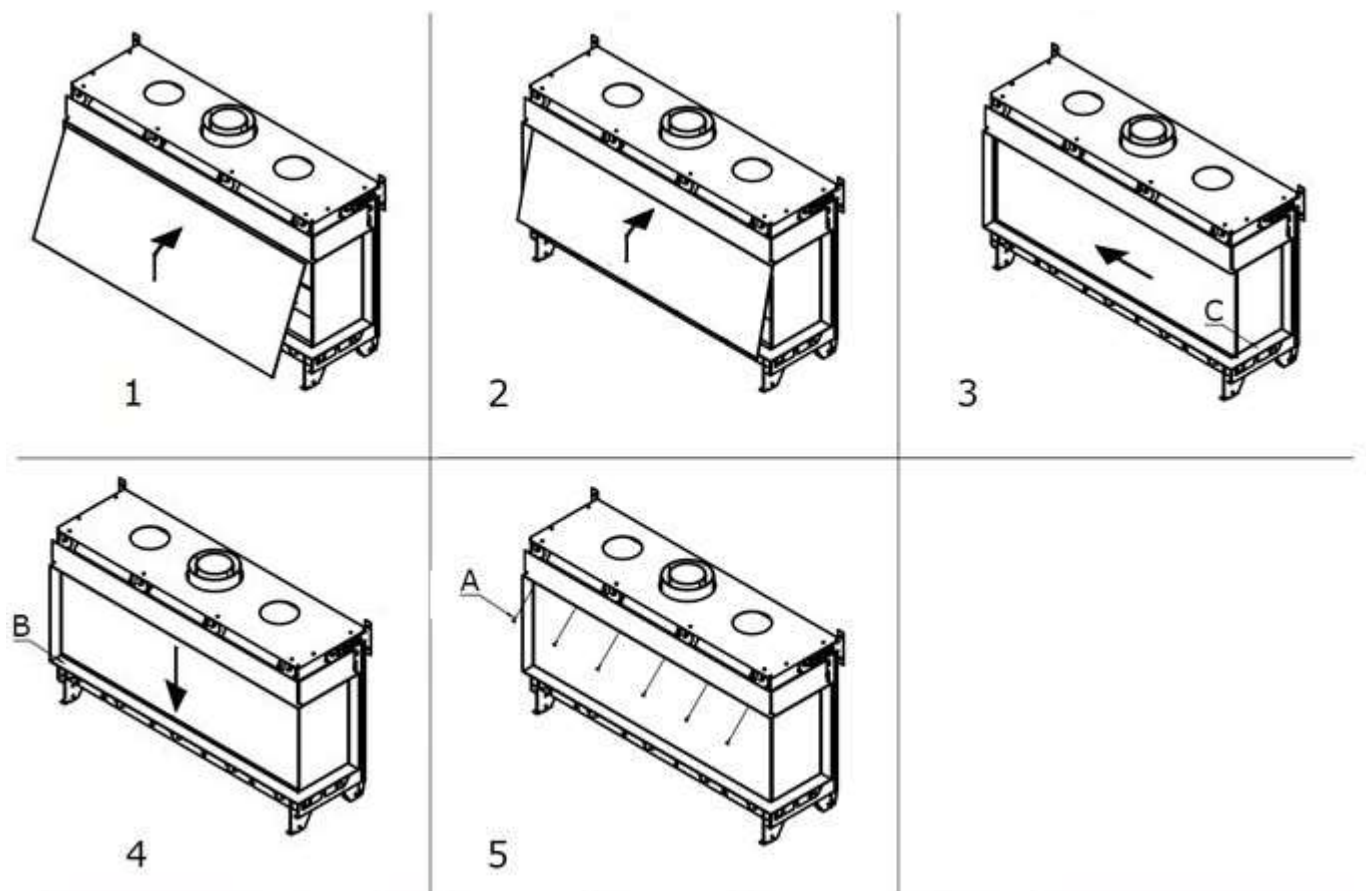

Picture 4: Mounting of the front glass in the fireplace with two glasses

To mount the front glass in the devices with three glasses, you must:

- Make sure the glass is clean, free from persistent dirt and fingerprints.
- Carefully mount the suction cup in the middle of the glass.
- Holding the glass at angle, insert its upper edge between the body of the fireplace and the horizontal fixing strip (1).
- Slide the glass upwards so that its lower edge is placed above the lower decorative frame "B" (2).
- Push lower edge of the glass in the direction of the body of the fireplace so that the surface of the glass is in vertical position.
- Move the glass down and carefully set its bottom edge inside the horizontal handle (3).
- Even out horizontally position of the front glass relative to the side walls so that the side edges of the front glass comport with the vertical edges of the side walls.
- Move the horizontal strip fixing the front glass to the right until it stops and tighten it with screws "A" (4).
- Make sure that the screws are not tightened too much, because it can then lead to their breakage or damage of the thread.
- Remove the suction cup.

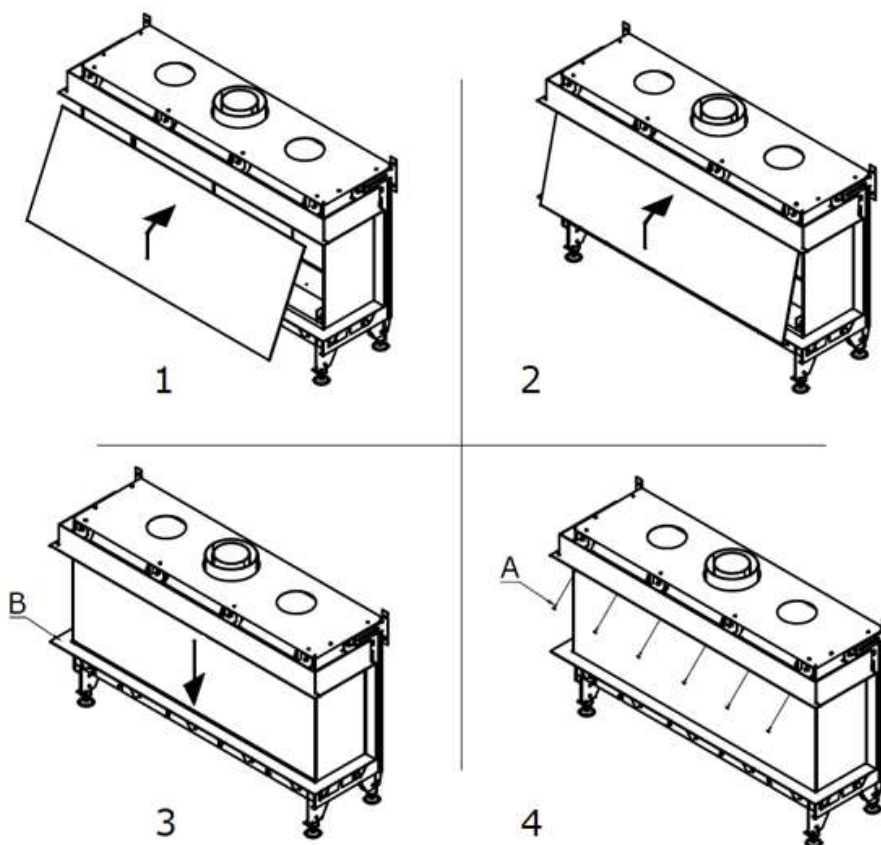

Picture 5 – Mounting of the front glass in the fireplace with three glasses

11.3. Disassembly of the glass

To disassembly the front glass of the device, you should follow the above procedure in reverse order, appropriate for the version of glazing.

If the device is a version equipped with side ceramic glass panes, they are not subject to removal during normal use or during the installation of the device.

To remove the front glass of the device with the front glazing should:

- Make sure the device is turned off, and the glasses are cooled down to room temperature.
- Carefully mount the suction cup in the middle of the glass.
- Remove the side pressure stripes „A” by lifting them up and moving them towards the center of the front glass (1).
- Unscrew the screws "B" pressing a horizontal strip "C" by holding the front glass (2).
- Move the pressure strip to the left and then move down to dismantle it (3).
- Lift the front glass vertically to the top so that its bottom edge is above the decorative frame "D" (4).
- Drag the lower part of the front glass to each other so that its lower edge is beyond the contour of the housing and decorative frame of the device (5).
- Then by making a move down and then towards yourself, you should pull out the front glass and put it in a safe place on a flat surface (6).
- Remove the suction cup.

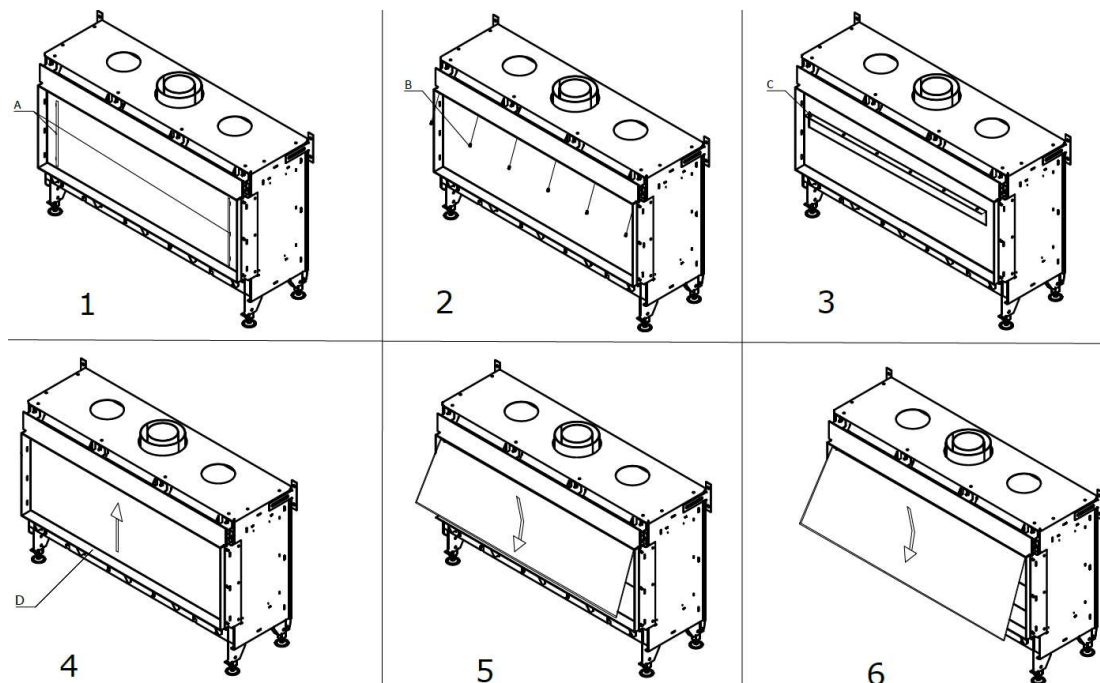

Picture 6 – Disassembly of the front glass in a fireplace with front glazing

To remove the front glass of the device with two glasses, you should:

- Make sure the device is turned off, and the glasses are cooled down to room temperature.
- Carefully mount the suction cup in the middle of the glass.
- Unscrew the screws "A" pressing a horizontal strip, holding the front glass (1).
- Move the pressure strip to the left and then move down to dismantle it.
- Lift the front glass pane vertically to the top so that its bottom edge is above the decorative frame "B" (2).
- Holding the glass at all times above the decorative frame "B" move carefully the glass, making sure that its right edge does not hit the decorative frame "C" (3).
- Drag the lower part of the front glass to each other so that its lower edge is beyond the contour of the housing and decorative frame of the device (4).
- Then by making a move down and then towards yourself, you should pull out the front glass and put it in a safe place on a flat surface (5).
- Remove the suction cup.

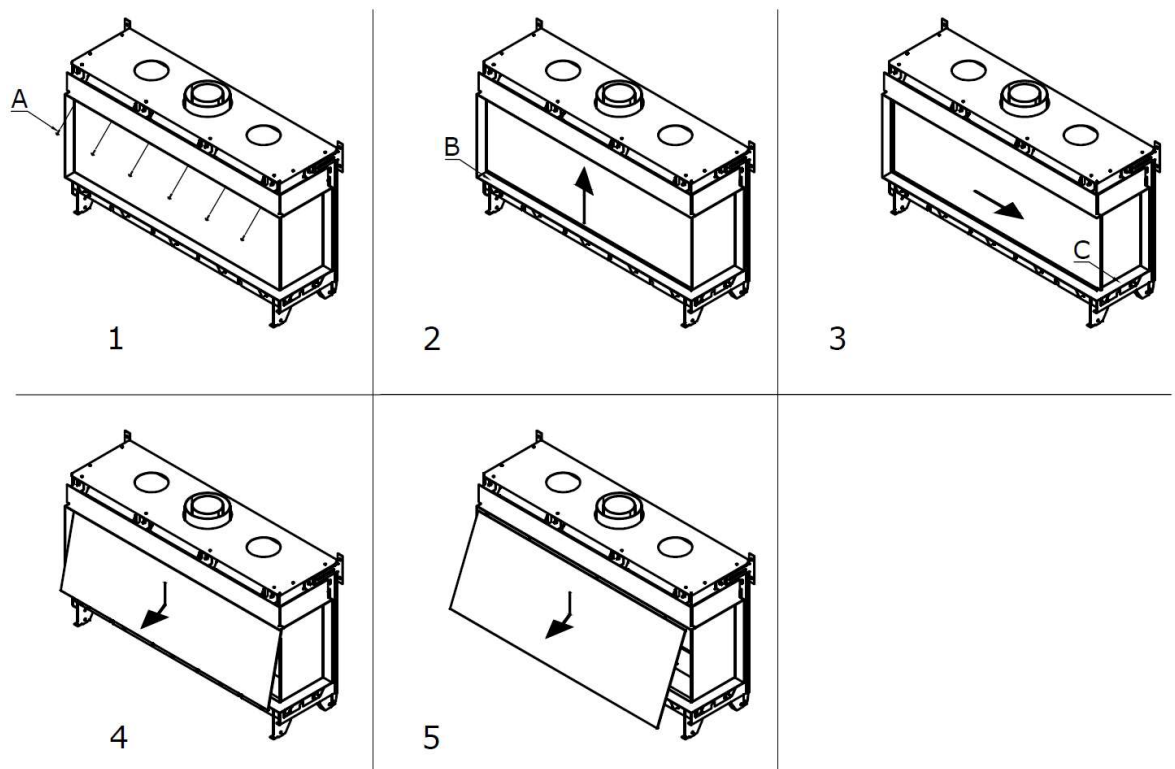

Picture 7 – Disassembly of the front glass in the fireplace with two glasses

To remove the front glass of the device with three glasses, you should:

- Make sure the device is turned off, and the glasses are cooled down to room temperature.
- Carefully mount the suction cup in the middle of the glass.
- Unscrew the screws "A" pressing a horizontal strip, holding the front glass (1).
- Move the pressure strip to the left and then move down to dismantle it.
- Lift the front glass vertically to the top so that its bottom edge is above the decorative frame "B" (2).
- Drag the lower part of the front glass to each other so that its lower edge is beyond the contour of the housing and decorative frame of the device (3).
- Then by making a move down and then towards yourself, you should pull out the front glass and put it in a safe place on a flat surface (4).
- Remove the suction cup.

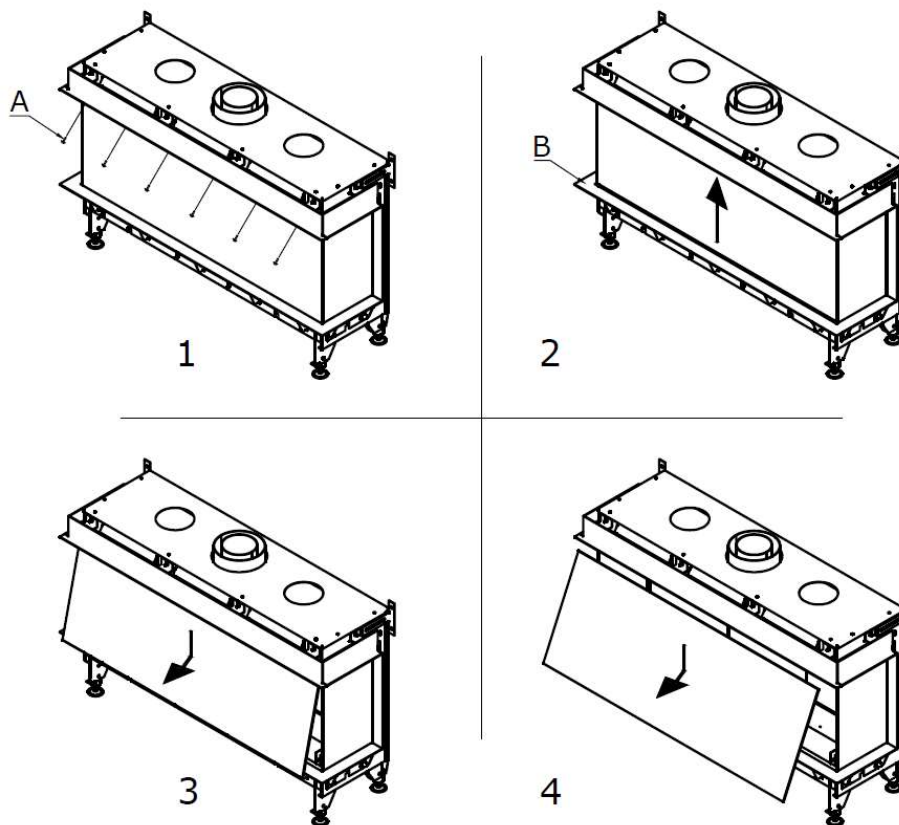

Picture 8 – Disassembly of the front glass in a fireplace with three glasses

12. ENVIRONMENTAL PROTECTION

Packaging materials must be utilized in accordance with regulations. Batteries are considered to be small chemical waste and should be disposed in special containers.

12.1. The device

When the unit reaches the end of its life, you should proceed carefully, so the parts are suitable for reuse.

Before removing the device, you should do the following:

- Close the gas valve.
- Disconnect the 230 V AC.
- Unscrew the cable connecting the device to the gas valve.
- Remove the device.

Do not place the product in unsorted waste and take it to an official collection point for this type of waste. For this purpose, please contact your local authorities for information about the available systems of delivery and acceptance of this type of waste.

13. WARRANTY

Planika Sp. z oo grants the Client guarantee of quality for the smooth operation of the goods specified on the sales document. The warranty is determined for a given period from the date of purchase (based on the warranty card together with the receipt of purchase). The warranty period starts at the moment of purchase of the original product by the first end user. Product may consist of several separate parts and different parts may be covered by a different warranty periods. The manufacturer gives 2 year warranty from date of purchase an insert for its smooth operation. Fireplace sealing is covered by warranty for a period of 1 year from date of purchase an insert. Guarantee does not cover: Decorative insulation panels, decorative ceramic logs and glass. The use of the fireplace insert, way of connecting to the chimney and operating conditions must be in accordance with the user manual. The basis for the free repair covered by warranty is a warranty card. Warranty Card will expire without a date, stamps, signatures, as well as the amendments made by unauthorized persons. Customer entitlement under the guarantee will expire automatically: after the warranty period. Any damages caused by improper handling, storage, of poor maintenance, incompatible with the conditions laid down in the manual and due to other reasons not due to the fault of the manufacturer, will void the warranty. In the event of a complaint, always contact your dealer. Supplier will contact the company Planika, if it deems it necessary. Factory Warranty is valid for 2 years from the date of purchase. Details of the warranty are available on the <http://www.warranty.planikafires.com/>.

14. TECHNICAL SPECIFICATIONS

TECHNICAL SPECIFICATIONS							
Name of the product	VALENTINO 1000 F, VALENTINO 1000 LF, VALENTINO 1000 FR, VALENTINO 1000 LFR						
Type of the device	To be built-in						
Combustion	Closed combustion chamber						
Supply and discharge system	Concentric Flue System 200/130						
Flame protection version	Separate ignition and ionization electrodes						
The safety valves for the purpose of pressure compensation	Yes						
Circulation hole in the fireplace wall	300 cm ²						
Type of the device	C11/C31/C91						
Appliance category	I2E(20), I2H(20)	I2L(25)	I2E+(20/25)	I3P(30) I3P(37) I3P(50)	I3B/P(30) I3B/P(37) I3B/P(50)	I3+(30/37)	
Reference Gas	G20	G25	G20/G25	G31	G30	G30/G31	
Nominal heat input (Hi)	kW	8,5			8,9		
Consumption on max output	m ³ /h	0,9			-		
Consumption on low output	m ³ /h	0,25 (*)			-		
Consumption on max output	kg/h	-			0,7		
Consumption on low output	kg/h	-			0,20 (*)		
Maximum burner pressure	mbar	14,0	21,0	18,5	27	27	26
Minimum burner pressure	mbar	5,5	5,5	5,5	9	9	9
Nozzle of the main burner	mm	1x Ø1,75	1x Ø1,75	1x Ø1,5	1x Ø1,1	1x Ø1,1	1x Ø1,05
Nozzles of the side burner	mm	2x Ø1,2	2x Ø1,2	2x Ø1,1	2x Ø0,8	2x Ø0,8	2x Ø0,75
Efficiency class		Class 2	Class 2	Class 2	Class 2	Class 2	Class 2
* - on minimal output, only the middle section switched on							

15. CONTACT DETAILS OF THE MANUFACTURER

Producent: Planika Sp. z o.o.
Dane kontaktowe: Bydgoska 38
 86-061 Brzoza
 Polska
Telefon: + 48 52 364 11 60
Fax: + 48 52 364 11 70